

# Differential pressure gauge with electrical output signal

## Model A2G-15

WIKA data sheet PV 17.40



for further approvals see  
page 3



### Applications

- Differential pressure monitoring for filters
- Pressure monitoring for ventilators
- Overpressure monitoring for clean rooms and also under- and overpressure monitoring for laboratories and operating rooms

### Special features

- Electrical output signal DC 0 ... 10 V (3-wire) or 4 ... 20 mA (2-wire)
- Simple and fast mounting via threaded bezel
- Separated construction of measuring chamber and display area
- Integrated sealing element for direct mounting in a ventilation duct or instrument panel
- Available as a built-in or add-on version



Differential pressure gauge with electrical output signal, add-on version, model A2G-15

### Description

The model A2G-15 differential pressure gauge with electrical output signal is used for monitoring the differential pressure in ventilation and air-conditioning applications. The measuring ranges cover from 0 ... 100 Pa to 0 ... 6,000 Pa. Plus/minus ranges can be fulfilled from -50 ... +50 Pa to -1,500 ... +1,500 Pa.

Electrical output signals for both measurands (DC 0 ... 10 V or 4 ... 20 mA) enable the direct connection to control systems or the building automation system.

The separated construction of the measuring chamber and display area ensures that impurities from the process air do not settle on the back of the window.

The differential pressure gauge is available in IP54 and IP65 ingress protection as well as two different mounting versions.

#### Built-in version

The built-in version with threaded bezel is notable for its fast and tool-free mounting. The built-in case features two back mount connections with a G 1/8 female thread, into which matching threaded pressure connections are screwed.

#### Add-on version

With the add-on version, the add-on case is attached with three screws and then the pressure measuring system is fitted into the case. The add-on case features two lower-mount connections with a G 1/8 female thread, into which matching threaded pressure connections are screwed. The position of each connection can be altered through 90° by rotating the add-on case.

# Specifications

| Differential pressure gauge with electrical output signal, model A2G-15 |   |
|---|---|
| <b>Version</b>  | <ul style="list-style-type: none"> <li>■ Standard version</li> <li>■ Silicone-free version</li> </ul>   |
| <b>Nominal size in mm</b>   | 110   |
| <b>Measuring range</b>  | <ul style="list-style-type: none"> <li>■ 0 ... 100 Pa to 0 ... 6,000 Pa</li> <li>■ -50 ... +50 Pa to -1,500 ... +1,500 Pa</li> </ul> Other plus/minus ranges on request |
| <b>Unit</b>   | <ul style="list-style-type: none"> <li>■ Pa</li> <li>■ kPa</li> <li>■ inWC</li> <li>■ mmWC</li> <li>■ mbar</li> </ul>   |
| <b>Scale</b>  | <ul style="list-style-type: none"> <li>■ Single scale</li> <li>■ Dual scale</li> </ul>  |
| <b>Accuracy class</b>   |   |
| Span $\geq$ 250 Pa  | 3.0   |
| Span 101 ... 249 Pa   | 5.0   |
| Span $\leq$ 100 Pa  | 10.0  |
| <b>Process connection</b>   | G 1/8 female<br>Threaded pressure connection for measuring hoses with inner diameter 4 ... 6 mm (see "Accessories")   |
| <b>Movement</b>   | Contact-free transmission (SWISS MOVEMENT)  |
| <b>Output signal</b>  | <ul style="list-style-type: none"> <li>■ DC 0 ... 10 V, 3-wire</li> <li>■ 4 ... 20 mA, 2-wire</li> </ul>  |
| <b>Supply voltage <math>U_B</math></b>                                  | DC 15 ... 35 V  |
| <b>Electrical connection</b>  | Cable gland M12   |
| <b>Materials</b>  |   |
| Case components   | <ul style="list-style-type: none"> <li>■ Plastic, glass-fibre reinforced</li> <li>■ Without</li> </ul>  |
| Separating diaphragm  | <ul style="list-style-type: none"> <li>■ Silicone</li> <li>■ EPDM (with silicone-free version)</li> </ul>   |
| Window  | Polycarbonate (UV stabilised)   |
| Dial  | Aluminium   |
| Pointer   | Plastic, black  |
| <b>Mark pointer</b>   | <ul style="list-style-type: none"> <li>■ Without</li> <li>■ Plastic, red</li> </ul>   |
| <b>Medium</b>   | <ul style="list-style-type: none"> <li>■ Air</li> <li>■ Non-flammable and non-aggressive gases</li> </ul>   |
| <b>Permissible temperature</b>  |   |
| Medium  | -16 ... +50 °C [-3 ... +122 °F]   |
| Ambient   | -30 ... +80 °C [-22 ... +176 °F]  |
| <b>Max. working pressure (static pressure)</b>                          | 20 kPa  |
| <b>Ingress protection per IEC/EN 60529</b>                              | <ul style="list-style-type: none"> <li>■ IP54</li> <li>■ IP65</li> </ul>  |
| <b>Weight (pressure measuring system)</b>                               | 255 g   |

## Electrical connection



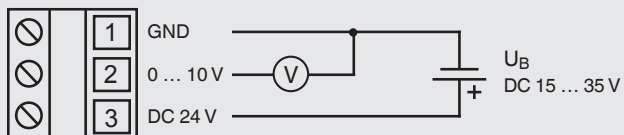

### DC 0 ... 10 V, 3-wire

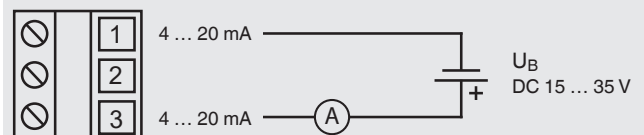

### 4 ... 20 mA, 2-wire



## Approvals (option)

| Logo  | Description   | Country                     |
|---|---|-----------------------------|
|  | <b>EAC</b><br>Import certificate                      | Eurasian Economic Community |
|  | <b>GOST</b><br>Metrology, measurement technology      | Russia                      |
|  | <b>KazInMetr</b><br>Metrology, measurement technology | Kazakhstan                  |
| -   | <b>MTSCHS</b><br>Permission for commissioning         | Kazakhstan                  |
|  | <b>UkrSEPRO</b><br>Metrology, measurement technology  | Ukraine                     |

## Certificates (option)

- Measurement report per EN 837
- 2.2 test report per EN 10204
- 3.1 inspection certificate per EN 10204

Approvals and certificates, see website

## Mounting versions

### Built-in version <sup>1)</sup>

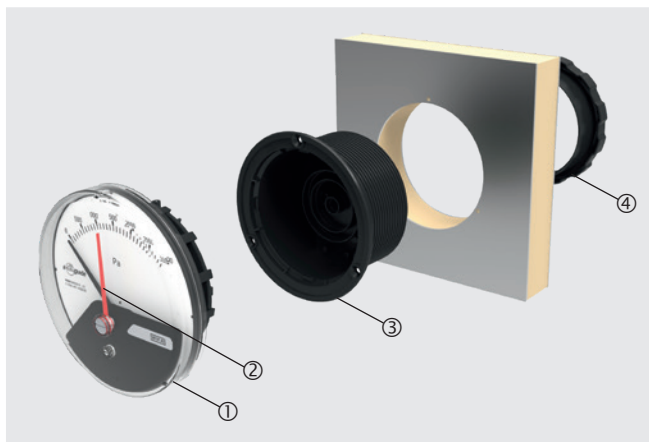

1) For wall thicknesses 1 ... 70 mm

### Add-on version

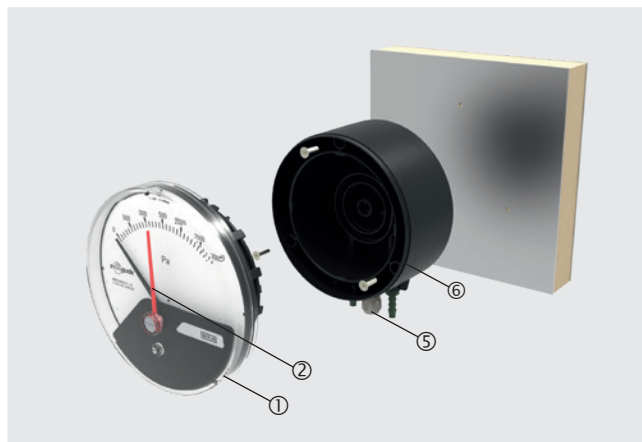

#### Legend

- ① Pressure measuring system
- ② Red mark pointer
- ③ Built-in case
- ④ Threaded bezel
- ⑤ Cable gland
- ⑥ Add-on case

# Dimensions in mm

## Built-in version with threaded bezel

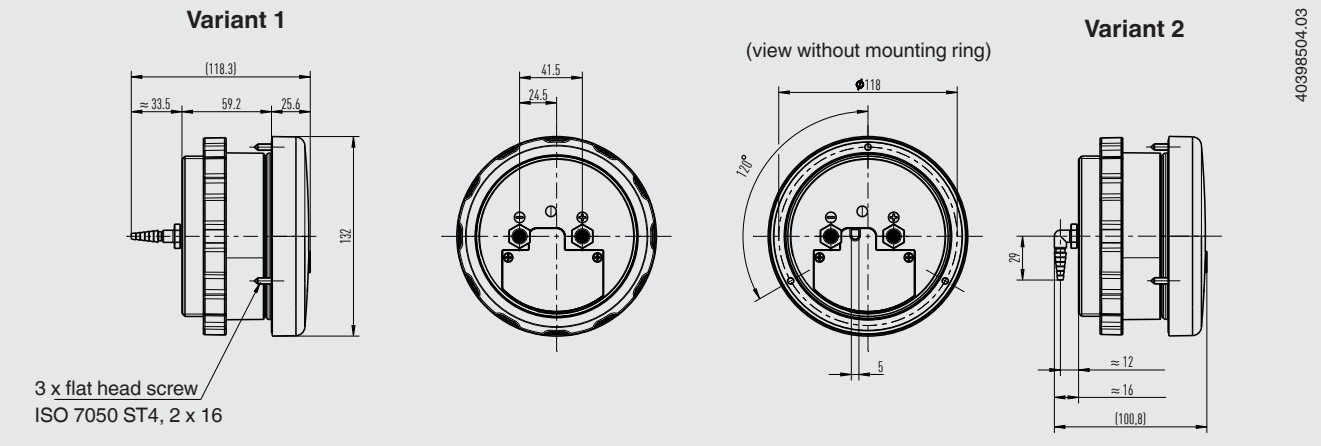



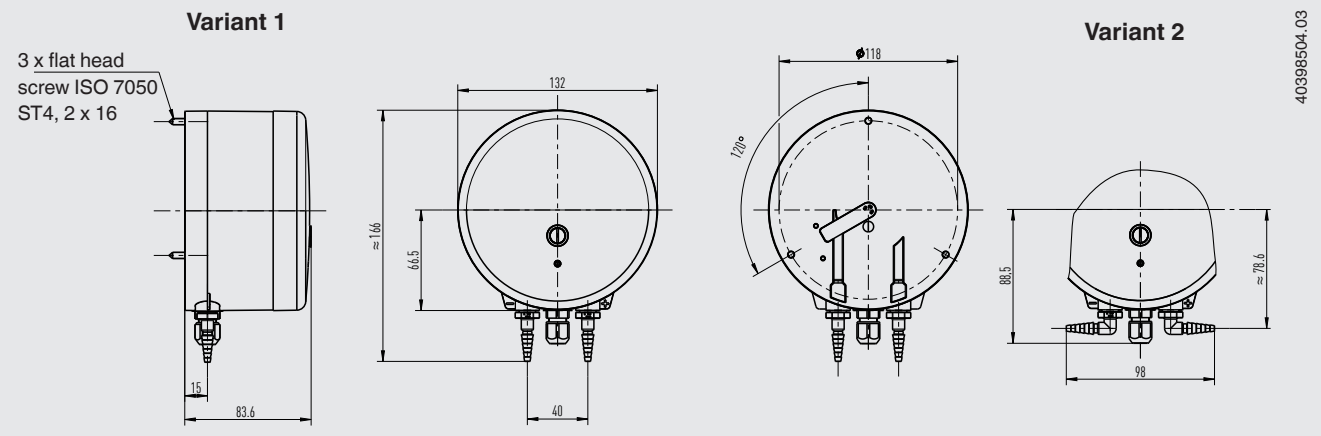







## Add-on version

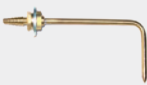
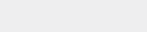
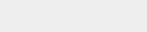

### Legend

- Variant 1: With threaded pressure connection, straight, ∅ 4 ... 6 mm
- Variant 2: With threaded pressure connection, angled, ∅ 4 ... 6 mm

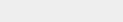
## Accessories

| Description   | Order number |
|---|--------------|
| <b>Process connections</b>  |              |
|  2 x threaded pressure connection, straight, Ø 4 ... 6 mm        | 40423607     |
|  2 x threaded pressure connection, angled, Ø 4 ... 6 mm          | 40423526     |
|  With mounting thread G 1/8 for pipes 6.35 mm/1/4"               | 40232867     |
|  Combi hose connection for pressure measuring hoses Ø 4 ... 7 mm | 40232484     |
| <b>Static duct probes with combi hose connection for pressure measuring hoses Ø 4 ... 7 mm</b>  |              |
|  Insertion length 100 mm   | 40232981     |
|  Insertion length 150 mm   | 40232999     |
|  Insertion length 200 mm   | 40233006     |
| <b>Measuring hoses</b>  |              |
|  PVC hose, inner diameter 4 mm, roll at 25 m                     | 40217841     |
|  PVC hose, inner diameter 6 mm, roll at 25 m                     | 40217850     |
|  Silicone hose, inner diameter 4 mm, roll at 25 m               | 40208940     |
|  Silicone hose, inner diameter 6 mm, roll at 25 m               | 40208958     |
|  <b>Duct connectors for measuring hoses Ø 4 ... 6 mm</b>       | 40217507     |
|  <b>Weather protection</b>                                     | 40241564     |

### Ordering information

Model / Version / Measuring range / Output signal / Unit / Scale / Ingress protection / Mark pointer / Mounting version / Accessories / Approvals / Certificates / Options

© 09/2008 WIKA Alexander Wiegand SE & Co. KG, all rights reserved.  
The specifications given in this document represent the state of engineering at the time of publishing.  
We reserve the right to make modifications to the specifications and materials.

